

SOD-323 Surface Mounted Zener Diode 表面贴装稳压二极管

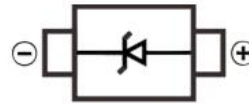

SOD-323

■ Absolute Maximum Ratings 最大额定值

Characteristic 特性参数	Symbol 符号	Rat 额定值	Unit 单位
Power dissipation 耗散功率	PD (Ta=25°C)	200	mW
Thermal Resistance Junction-Ambient 热阻	R _{θJA}	625	°C/W
Forward Voltage 正向电压	V _F (@ I _F =10mA)	0.9	V
Reverse Voltage 反向电压	V _Z	2.4-43	V
Junction and Storage Temperature 结温和储藏温度	T _J , T _{stg}	150°C, -65to+150°C	

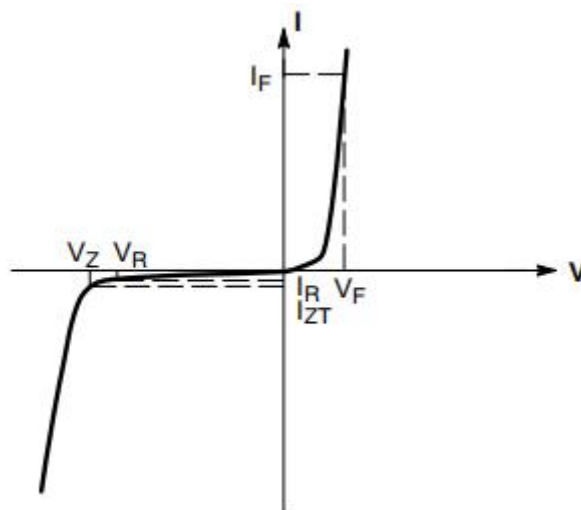

■ Electrical Characteristics 电特性

($T_A=25^{\circ}\text{C}$ unless otherwise noted 如无特殊说明, 温度为 25°C)

Type	$V_Z(\text{V})$		DIFFERENTIAL RESISTANCE $r_{\text{dif}}(\Omega)$				TEMP. COEFF. $S_z(\text{mV/K})$			$I_R(\mu\text{A})$ @ $V_R(\text{V})$		Mark ing
	@ $I_{ZT}=5\text{mA}$		@ $I_{ZK}=1\text{mA}$		@ $I_{ZT}=5\text{mA}$		@ $I_{ZT}=5\text{mA}$			I_R	@ V_R	
	MIN.	MAX.	TYP.	MAX.	TYP.	MAX.	MIN.	TYP.	MAX.			
BZT52B2V4S	2.35	2.45	325	600	80	100	-3.5	-2.1	0	50	1	WX
BZT52B2V7S	2.64	2.76	325	600	80	100	-3.5	-2.1	0	20	1	W1
BZT52B3V0S	2.94	3.06	325	600	80	95	-3.5	-2.1	0	10	1	W2
BZT52B3V3S	3.23	3.37	350	600	85	95	-3.5	-2.4	0	5	1	W3
BZT52B3V6S	3.52	3.68	375	600	85	90	-3.5	-2.4	0	5	1	W4
BZT52B3V9S	3.82	3.98	400	600	85	90	-3.5	-2.5	0	3	1	W5
BZT52B4V3S	4.21	4.39	400	600	85	90	-3.5	-2.5	0	3	1	W6
BZT52B4V7S	4.6	4.8	410	600	80	90	-3.5	-2.5	0	3	2	W7
BZT52B5V1S	4.99	5.2	425	500	50	80	-3.5	-1.4	0.2	2	2	W8
BZT52B5V6S	5.49	5.71	400	480	40	60	-2.7	-0.8	1.2	1	2	W9
BZT52B6V2S	6.07	6.32	80	400	15	40	-2.0	1.2	2.5	3	4	WA
BZT52B6V8S	6.66	6.94	40	150	6	10	0.4	2.3	3.7	2	4	WB
BZT52B7V5S	7.35	7.65	30	80	6	15	1.2	3.0	4.5	1	5	WC
BZT52B8V2S	8.04	8.36	30	80	6	15	2.5	4.0	5.3	0.7	5	WD
BZT52B9V1S	8.92	9.28	40	80	6	15	3.2	4.6	6.2	0.5	6	WE
BZT52B10S	9.8	10.2	40	100	6	15	3.8	5.5	7.0	0.2	7	WF
BZT52B11S	10.8	11.2	50	150	8	20	4.5	6.4	8.0	0.1	8	WG
BZT52B12S	11.8	12.2	50	150	10	20	5.4	7.4	9.0	0.1	8	WH
BZT52B13S	12.7	13.3	50	150	10	25	6.0	8.4	10.0	0.1	8	WI
BZT52B15S	14.7	15.3	50	170	10	30	7.0	9.4	11.0	0.05	10.5	WJ
BZT52B16S	15.7	16.3	50	200	10	30	9.2	11.4	13.0	0.05	11.2	WK
BZT52B18S	17.6	18.4	50	200	10	40	10.4	12.4	14.0	0.05	12.6	WL
BZT52B20S	19.6	20.4	50	225	10	45	12.4	14.4	16.0	0.05	14	WM
BZT52B22S	21.6	22.5	60	225	15	55	14.4	16.4	18.0	0.05	15.4	WN
BZT52B24S	23.5	24.5	60	250	20	55	16.4	18.4	20.0	0.05	16.8	WO
BZT52B27S	26.4	27.6	65	300	25	80	21.4	23.4	25.3	0.05	18.9	WP
BZT52B30S	29.4	30.6	70	300	30	80	24.4	26.6	29.4	0.05	21	WQ
BZT52B33S	32.3	33.7	75	325	35	80	27.4	29.7	33.4	0.05	23.1	WR
BZT52B36S	35.2	36.8	80	350	35	90	30.4	33.0	37.4	0.05	25.2	WS
BZT52B39S	38.2	39.8	80	350	40	130	33.4	36.4	41.2	0.05	27.3	WT
BZT52B43S	42.1	43.9	85	375	45	150	37.6	41.2	46.6	0.05	30.1	WU

■ Typical Characteristic Curve 典型特性曲线

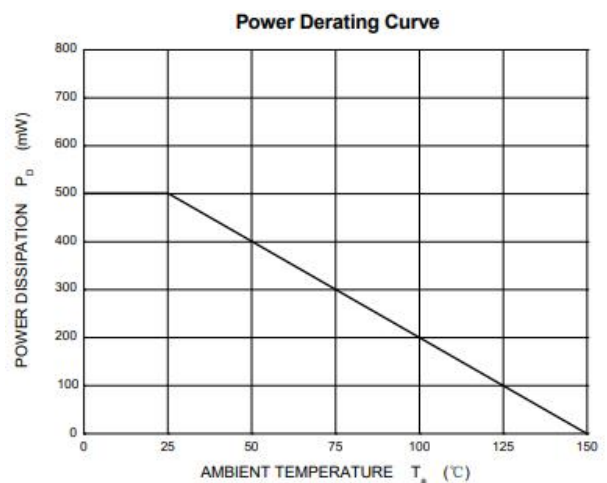
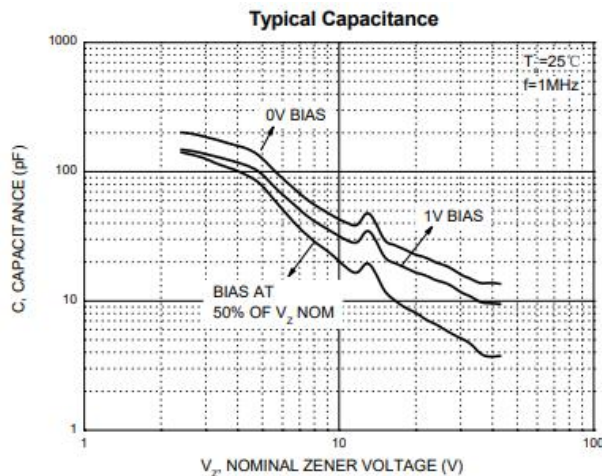
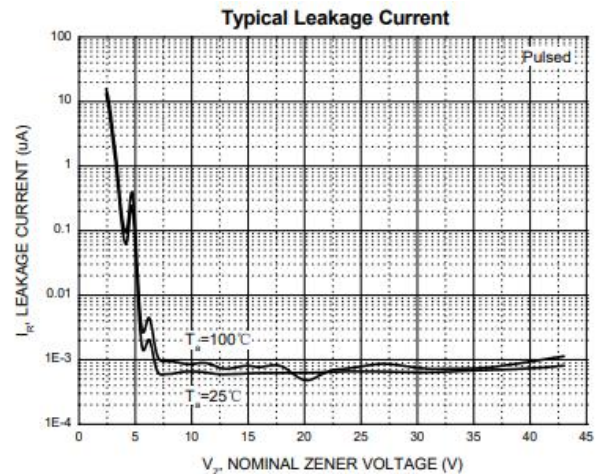
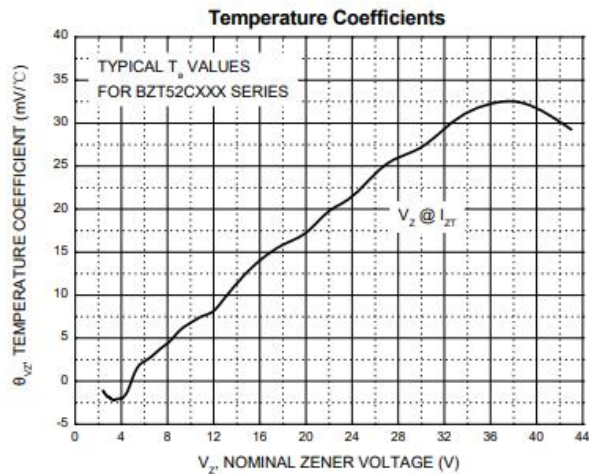
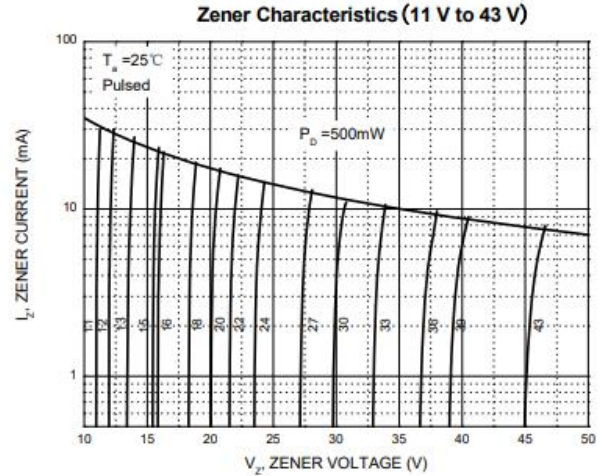
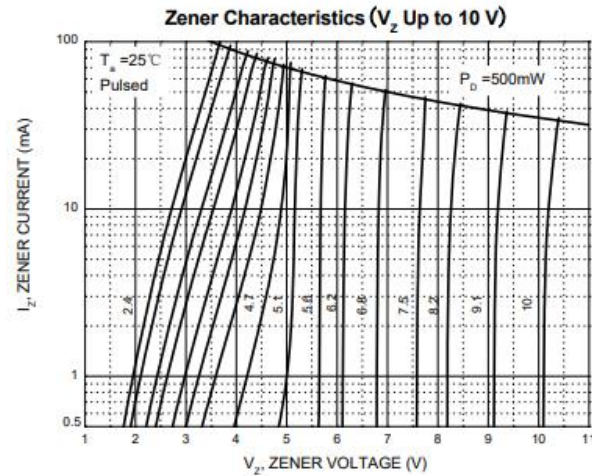

■Dimension 外形封装尺寸

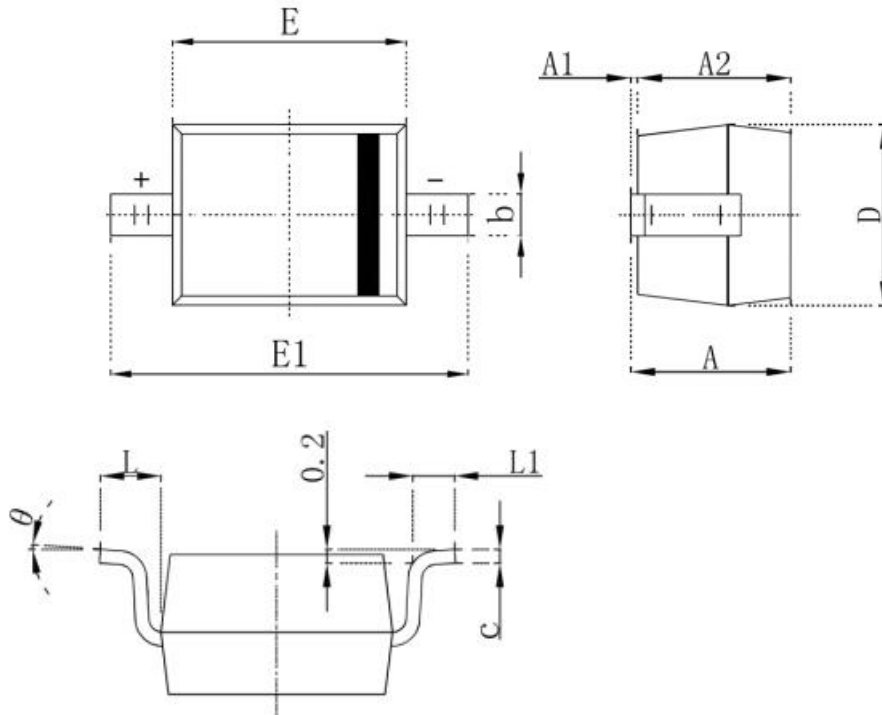

Symbol	Dimensions In Millimeters		Dimensions In Inches	
	Min.	Max.	Min.	Max.
A		1.000		0.039
A1	0.000	0.100	0.000	0.004
A2	0.800	0.900	0.031	0.035
b	0.250	0.350	0.010	0.014
c	0.080	0.150	0.003	0.006
D	1.200	1.400	0.047	0.055
E	1.600	1.800	0.063	0.071
E1	2.250	2.750	0.100	0.108
L	0.475 REF		0.019 REF	
L1	0.250	0.400	0.010	0.016
θ	0°	8°	0°	8°