

**PDFN3.3X3.3-8 P Channel Enhancement 沟道增强型
MOS Field Effect Transistor 场效应管**

■ Features 特点

Low on-resistance 低导通电阻

$R_{DS(ON)}=9m\Omega(\text{Type})@V_{GS}=-10V$

$R_{DS(ON)}=14.7m\Omega(\text{Type})@V_{GS}=-4.5V$

■ Applications 应用

Backlight 背光驱动

DC-DC Conversion 升压转换

Power Management 电源管理

■ Internal Schematic Diagram 内部结构

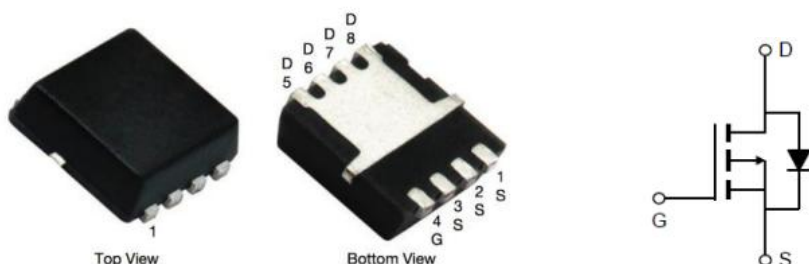

■ Absolute Maximum Ratings 最大额定值

Characteristic 特性参数	Symbol 符号	Rat 额定值	Unit 单位
Drain-Source Voltage 漏极-源极电压	BV_{DSS}	-30	V
Gate- Source Voltage 栅极-源极电压	V_{GS}	± 20	V
Drain Current (continuous)漏极电流-连续	I_D (at $T_C=25^\circ C$ at $T_A=25^\circ C$)	-44 -15	A
Drain Current (pulsed)漏极电流-脉冲	I_{DM}	-176	A
Total Device Dissipation 总耗散功率	P_{TOT} (at $T_C=25^\circ C$ at $T_A=25^\circ C$)	30 3.1	W
Avalanche Energy(Single Pulse)雪崩能量	E_{AS}	101	mJ
Thermal Resistance Junction-Ambient 热阻	$R_{\theta JC}/R_{\theta JA}$	4.1/40	$^\circ C/W$
Junction/Storage Temperature 结温/储存温度	T_J, T_{stg}	-55~150	$^\circ C$

■ **Electrical Characteristics 电特性**

($T_A=25^{\circ}\text{C}$ unless otherwise noted 如无特殊说明, 温度为 25°C)

Characteristic 特性参数	Symbol 符号	Min 最小值	Typ 典型值	Max 最大值	Unit 单位
Drain-Source Breakdown Voltage 漏极-源极击穿电压($I_D = -250\mu\text{A}, V_{GS}=0\text{V}$)	BV_{DSS}	-30	—	—	V
Gate Threshold Voltage 栅极开启电压($I_D = -250\mu\text{A}, V_{GS} = V_{DS}$)	$V_{GS(th)}$	-1	-1.5	-3	V
Zero Gate Voltage Drain Current 零栅压漏极电流($V_{GS}=0\text{V}, V_{DS} = -30\text{V}$)	I_{DSS}	—	—	-1	μA
Gate Body Leakage 栅极漏电流($V_{GS}=\pm 20\text{V}, V_{DS}=0\text{V}$)	I_{GSS}	—	—	± 100	nA
Static Drain-Source On-State Resistance 静态漏源导通电阻($I_D = -15\text{A}, V_{GS} = -10\text{V}$) ($I_D = -10\text{A}, V_{GS} = -4.5\text{V}$)	$R_{DS(ON)}$	—	9 14.7	14 20	$\text{m}\Omega$
Diode Forward Voltage Drop 内附二极管正向压降($I_{SD} = -1\text{A}, V_{GS}=0\text{V}$)	V_{SD}	—	-0.7	-1	V
Input Capacitance 输入电容 ($V_{GS}=0\text{V}, V_{DS} = -15\text{V}, f=1\text{MHz}$)	C_{ISS}	—	2147	—	pF
Common Source Output Capacitance 共源输出电容($V_{GS}=0\text{V}, V_{DS} = -15\text{V}, f=1\text{MHz}$)	C_{OSS}	—	407	—	pF
Reverse Transfer Capacitance 反馈电容 ($V_{GS}=0\text{V}, V_{DS} = -15\text{V}, f=1\text{MHz}$)	C_{RSS}	—	358	—	pF
Total Gate Charge 栅极电荷密度 ($V_{DS} = -15\text{V}, I_D = -11.5\text{A}, V_{GS} = -10\text{V}$)	Q_g	—	51	—	nC
Gate Source Charge 栅源电荷密度 ($V_{DS} = -15\text{V}, I_D = -11.5\text{A}, V_{GS} = -10\text{V}$)	Q_{gs}	—	8	—	nC
Gate Drain Charge 栅漏电荷密度 ($V_{DS} = -15\text{V}, I_D = -11.5\text{A}, V_{GS} = -10\text{V}$)	Q_{gd}	—	15	—	nC
Turn-ON Delay Time 开启延迟时间 ($V_{DS} = -15\text{V}, I_D = -1\text{A}, R_{GEN}=6\Omega, V_{GS} = -10\text{V}$)	$t_{d(on)}$	—	8	—	ns
Turn-ON Rise Time 开启上升时间 ($V_{DS} = -15\text{V}, I_D = -1\text{A}, R_{GEN}=6\Omega, V_{GS} = -10\text{V}$)	t_r	—	20	—	ns
Turn-OFF Delay Time 关断延迟时间 ($V_{DS} = -15\text{V}, I_D = -1\text{A}, R_{GEN}=6\Omega, V_{GS} = -10\text{V}$)	$t_{d(off)}$	—	58	—	ns
Turn-OFF Fall Time 关断下降时间 ($V_{DS} = -15\text{V}, I_D = -1\text{A}, R_{GEN}=6\Omega, V_{GS} = -10\text{V}$)	t_f	—	43	—	ns

■ Typical Characteristic Curve 典型特性曲线

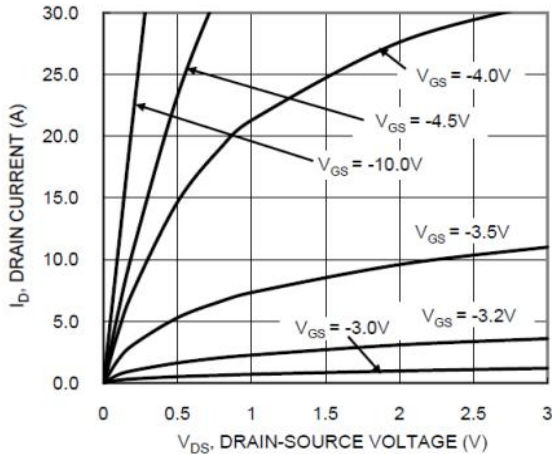

Figure 1: Output Characteristics

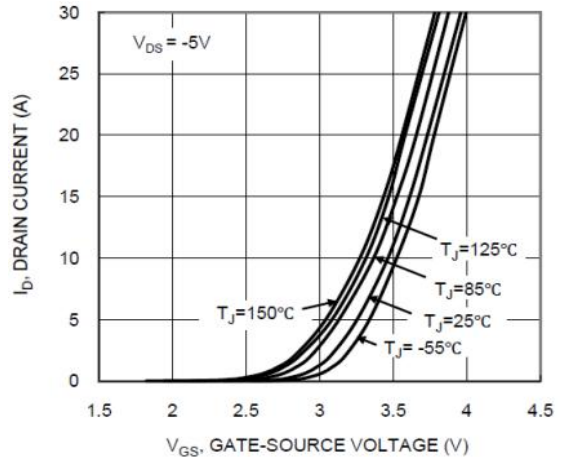

Figure 2: Transfer Characteristics

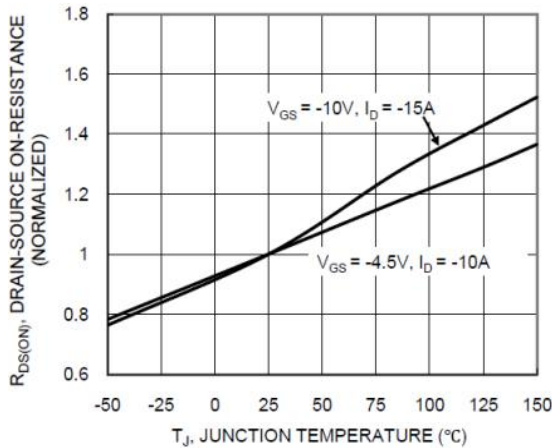

Figure 3: On-Resistance vs. T_J

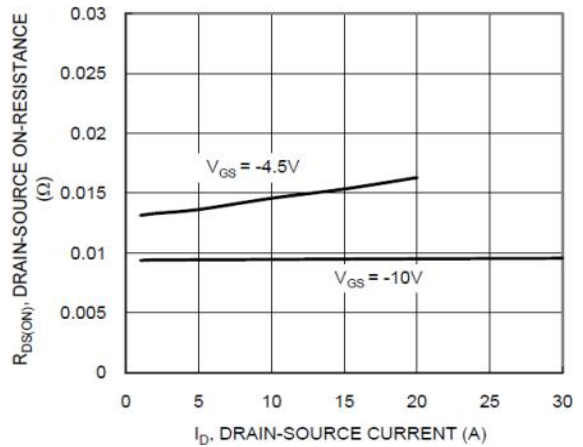

Figure 4: On-Resistance vs. Drain Current

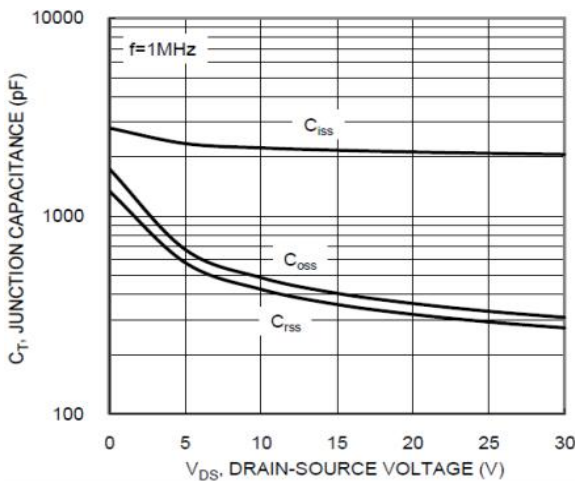

Figure 5: Capacitance Characteristics

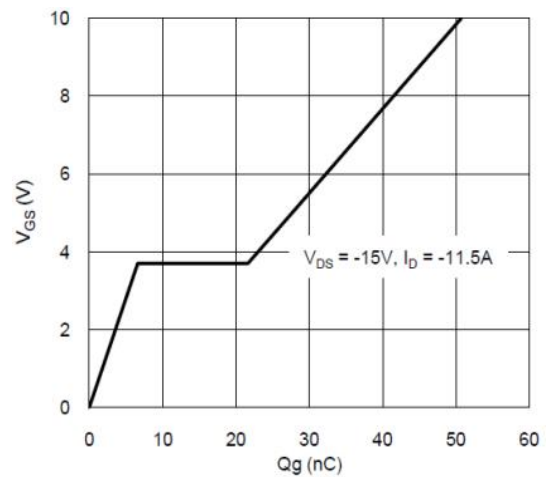

Figure 6: Gate-Charge Characteristics

■ Typical Characteristic Curve 典型特性曲线

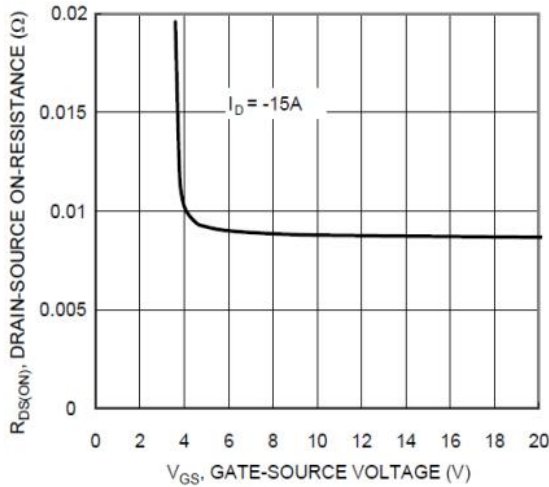

Figure 7: On-Resistance vs. V_{GS}

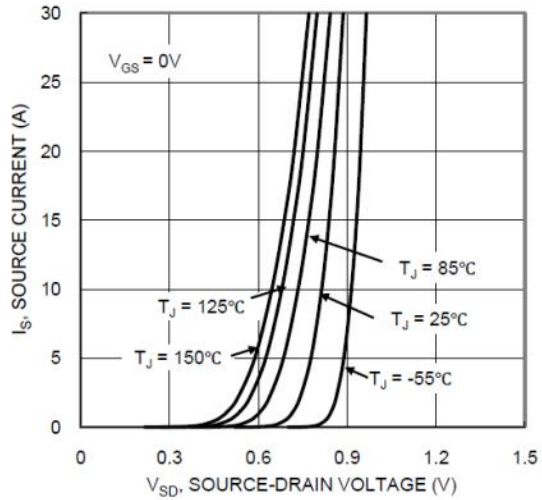

Figure 8: Diode Characteristics

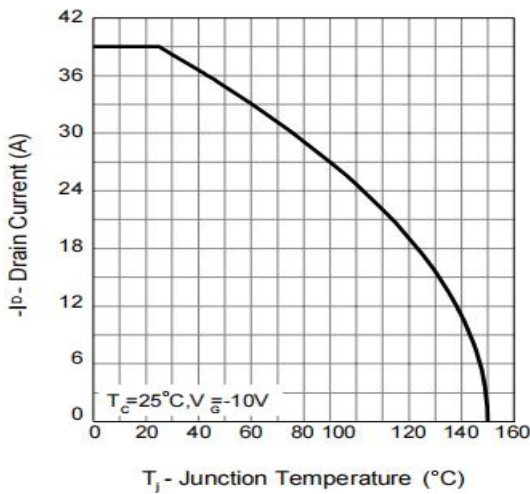

Figure 9: Drain Current Characteristics

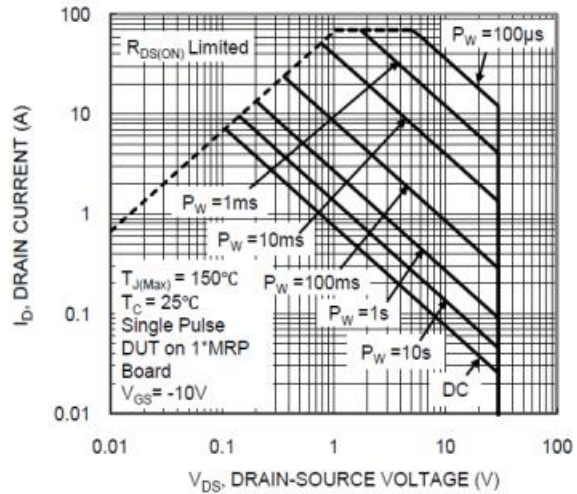

Figure 10: Safe Operating Area

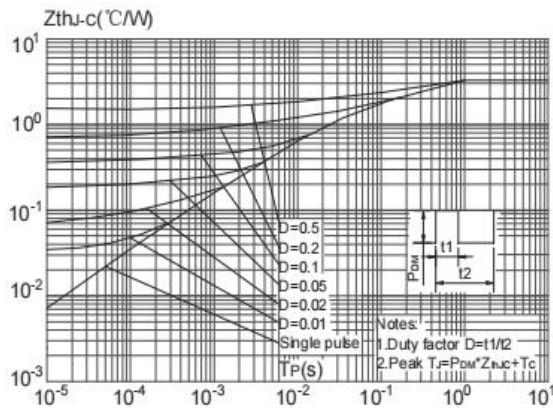
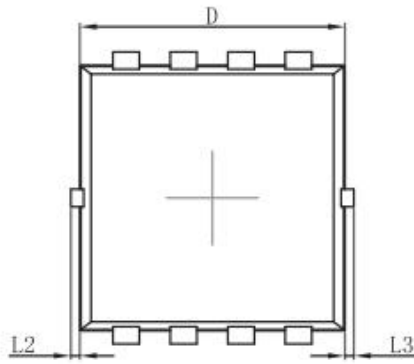
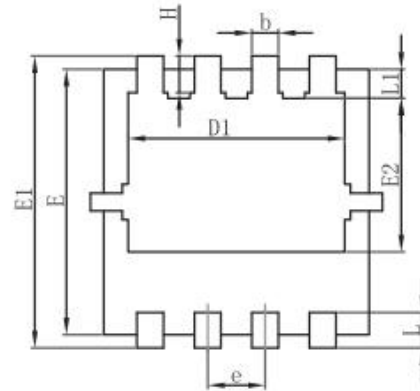

Figure 11: Transient Thermal Response Curve

■ Dimension 外形封装尺寸



Top View



Bottom View

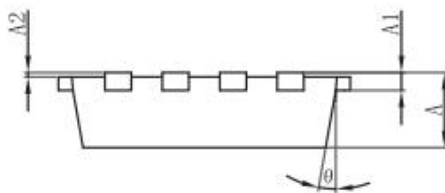

Side View

Symbol	Dimensions In Millimeters		Dimensions In Inches	
	Min.	Max.	Min.	Max.
A	0.650	0.850	0.026	0.033
A1	0.152 REF.		0.006 REF.	
A2	0~0.05		0~0.002	
D	2.900	3.100	0.114	0.122
D1	2.300	2.600	0.091	0.102
E	2.900	3.100	0.114	0.122
E1	3.150	3.450	0.124	0.136
E2	1.535	1.935	0.060	0.076
b	0.200	0.400	0.008	0.016
e	0.550	0.750	0.022	0.030
L	0.300	0.500	0.012	0.020
L1	0.180	0.480	0.007	0.019
L2	0~0.100		0~0.004	
L3	0~0.100		0~0.004	
H	0.315	0.515	0.012	0.020
θ	9°	13°	9°	13°