



安徽富信半导体科技有限公司

ANHUI FOSAN SEMICONDUCTOR TECHNOLOGY CO., LTD.

SS22-SS210

SMA Schottky Barrier Rectifier Diode 肖特基势垒整流二极管

■ Features 特点

Low forward voltage drop 低正向压降

High current capability 高电流能力

Surface mount device 表面贴装器件

Case 封装:SMA(DO-214AC)

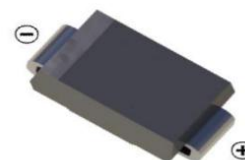

■ Maximum Rating 最大额定值

($T_A=25^{\circ}\text{C}$ unless otherwise noted 如无特殊说明, 温度为 25°C)

| Characteristic 特性参数 | Symbol 符号 | SS22 | SS23 | SS24 | SS25 | SS26 | SS28 | SS29 | SS210 | Unit 单位 |
|----------------------------------|-----------------|------------------------------|------|------|------|------|------|------|-------|-----------------------------|
| Peak Reverse Voltage 反向峰值电压 | V_{RRM} | 20 | 30 | 40 | 50 | 60 | 80 | 90 | 100 | V |
| DC Reverse Voltage 直流反向电压 | V_R | 20 | 30 | 40 | 50 | 60 | 80 | 90 | 100 | V |
| RMS Reverse Voltage 反向电压均方根值 | $V_{R(RMS)}$ | 14 | 21 | 28 | 35 | 42 | 56 | 63 | 70 | V |
| Forward Rectified Current 正向整流电流 | I_F | 2 | | | | | | | | A |
| Peak Surge Current 峰值浪涌电流 | I_{FSM} | 50 | | | | | | | | A |
| Thermal Resistance J-A 结到环境热阻 | $R_{\theta JA}$ | 75 | | | | | | | | $^{\circ}\text{C}/\text{W}$ |
| Junction Temperature 结温 | T_J | 150 | | | | | | | | $^{\circ}\text{C}$ |
| Storage Temperature 储藏温度 | T_{stg} | -65to+150 $^{\circ}\text{C}$ | | | | | | | | $^{\circ}\text{C}$ |

■ Electrical Characteristics 电特性

($T_A=25^{\circ}\text{C}$ unless otherwise noted 如无特殊说明, 温度为 25°C)

| Characteristic 特性参数 | Symbol 符号 | SS22-SS24 | SS25-SS26 | SS28-SS210 | Unit 单位 | Condition 条件 |
|-------------------------|--|-----------|-----------|------------|---------|--------------------------------|
| Forward Voltage 正向电压 | V_F | 0.55 | 0.70 | 0.85 | V | $I_F=2\text{A}$ |
| Reverse Current 反向电流 | $I_R(25^{\circ}\text{C})$ (100°C) | 0.1 5 | | 0.02 2 | mA | $V_R=V_{RRM}$ |
| Diode Capacitance 二极管电容 | C_D | 170 | | | pF | $V_R=4\text{V}, f=1\text{MHz}$ |

■ Typical Characteristic Curve 典型特性曲线

FIG.1-TYPICAL FORWARD CURRENT DERATING CURVE

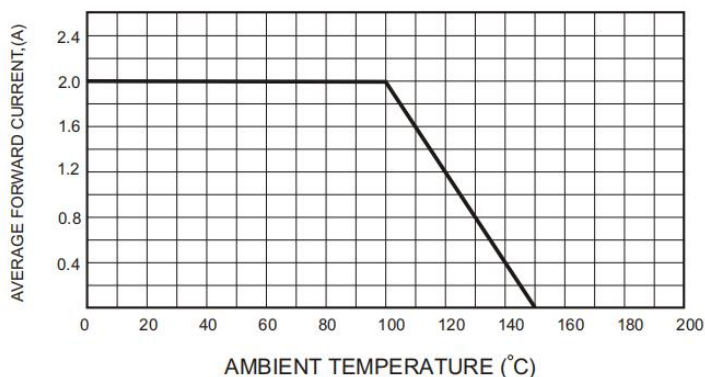

FIG.2-TYPICAL FORWARD

CHARACTERISTICS

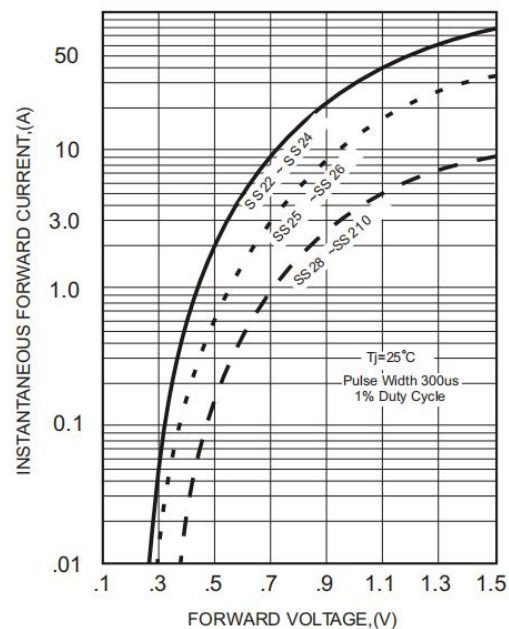

FIG.3-MAXIMUM NON-REPETITIVE FORWARD SURGE CURRENT

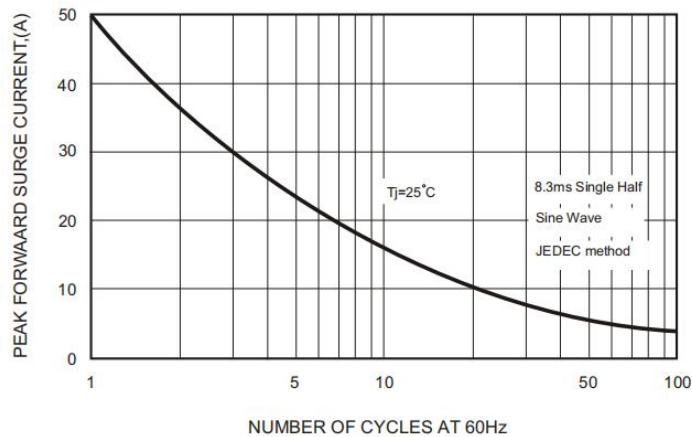

FIG.5 - TYPICAL REVERSE

CHARACTERISTICS

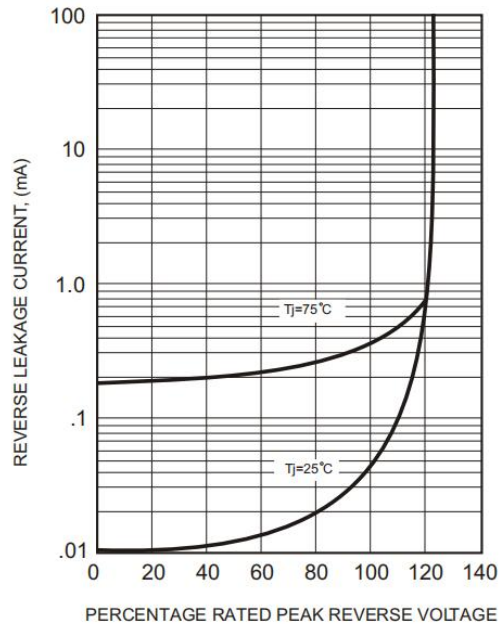
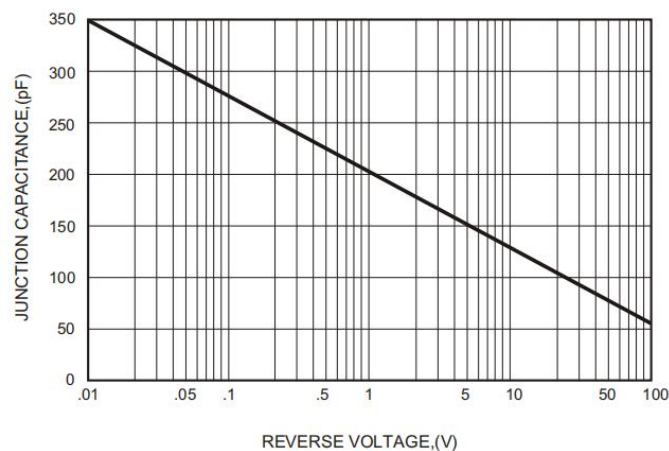
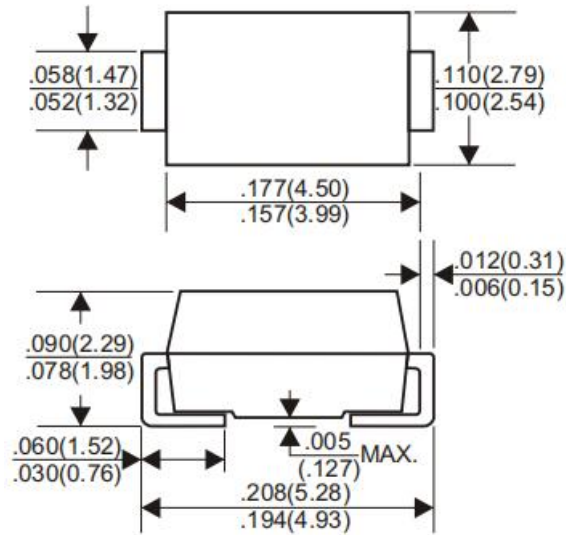

FIG.4-TYPICAL JUNCTION CAPACITANCE



■Dimension 外形封装尺寸

DO-214AC(SMA)



Dimensions in inches and (millimeters)